

GORRHINO®

INSTALLATION INSTRUCTIONS



- Part Number
34389T
- Product Description:
Element Front Bumper Replacement
- Vehicle Application:
2016-2021 Toyota Tacoma

LIGHT BAR NOT INCLUDED

PRODUCT SAFETY & LEGAL DISCLAIMER

- **This product requires cutting of the original bumper and fender liner. It is recommended to seek profesional installation for installation. The installer assumes all responsibility for installation and issues that may occur during installation.**
- **IMPORTANT READ ALL INSTRUCTIONS CAREFULLY BEFORE INSTALLING, FAILURE TO DO SO MAY CAUSE PERSONAL INJURY OR DAMAGE TO PRODUCT AND/OR PROPERTY.**
- **Review the product package and contents prior to beginning the installation.** Take care when opening the packaging and removing items. If a return is needed you will want to return the product in its original packaging if possible.
- This instruction guide is provided as a GENERAL installation guide, some vehicles vary dimensionally and may require additional steps.
- Test fit the product on the vehicle prior to any third party modifications and or finishing. The manufacturer and/or distributors do not accept responsibility for third party charges, labor and or third part replacement modifications. Some modifications may void the factory warranty.
- Exercise due-diligence when installing this product. The manufacturer and distributors of this product do not accept any responsibility for vehicle damage or personal injury resulting from the installation of this product. Careless installation and operation can result in serious injury or equipment damage.
- This product is for general off-road use. All liability for installation and use rests with the owner/operator.
- **INSTALLER:** Once installation is complete, please return this guide along with other documentation included in this product back to the consumer for future reference. The manufacturer/distributors of this product do not guarantee this particular version will be available at a later date.

© 2016 Go Rhino Products. All rights reserved



INSTALLATION INSTRUCTIONS

INJURY HAZARD

Please complete a shop and tool inspection prior to beginning the installation.

- Always make sure you have a clean, dry and well lit work area.
- Always remove jewelry, loose fitting clothing and wear protective gloves and eye protection.
- Always use extreme caution when jacking or raising a vehicle for work. Set the emergency brake and use tire/wheel blocks and jack stands. Refer to the vehicle manufacturer hand book. Utilize the vehicle manufacturers designated lifting points.
- Always use appropriate and adequate care in lifting parts during disassembly and installation. Seek help in lifting heavy or large items into place. Utilize jacks and or lifting devices when available.
- Always insure products are secure during disassembly and installation.
- Always wear eye protection and take steps to protect any exposed skin during the installations. Drilling, cutting and grinding plastic and metal may create flying particles that can cause injury.
- Always use extreme caution when drilling, cutting and or grinding on a vehicle. Thoroughly inspect the area to be drilled, on both sides of material, prior to modification and relocate any objects that may become damaged.
- Always assemble and tighten all fasteners per the installation instructions.
- Always route electrical cables carefully. Avoid moving parts, parts that may become hot and rough or sharp edges.
- Always insulate and protect all exposed wiring and electrical connections.

MAINTENANCE AND CARE

- Always perform regular inspections and maintenance on mounts and related fasteners.
- Periodically check and tighten all fasteners.
- Stripped, fractured, or bent fasteners must be replaced.
- After washing the vehicle make sure to fully dry all surfaces.
- In areas with cold temperatures make sure to wash the product often to remove harmful materials used on road ways.
- Never use abrasive cleaners or polish compounds. Clean with a gentle soap and water. If you use wax use a non-abrasive automotive wax such as pure carnauba wax.

WARNING

Some products have been designed to work together with factory rear sensor systems, factory forward facing sensor systems and factory air bags.

- Installation of some of these products may alter the factory sensor system performance.
- Factory sensors may read shackles or hooks protruding from the fairlead and or tow hooks.
- All sensor testing is completed by Go Rhino Products and or third party testing labs on modified vehicles.
- Sensor sensitivity, factory sensor housing, orientation, and operating conditions are all variables that will influence functionality of the sensors.
- Installation of some product may effect the factory air bag systems.
- Some products allow the use of third party products such as winches, shackles, hooks, etc. Follow the respective manufacturers operating instructions for use with our products.
- Make sure to fully understand the product, it's intended use and operation prior to use.
- Above all... be safe!

GO RHINO®

INSTALLATION INSTRUCTIONS

PARTS INCLUDED IN THIS LIST:

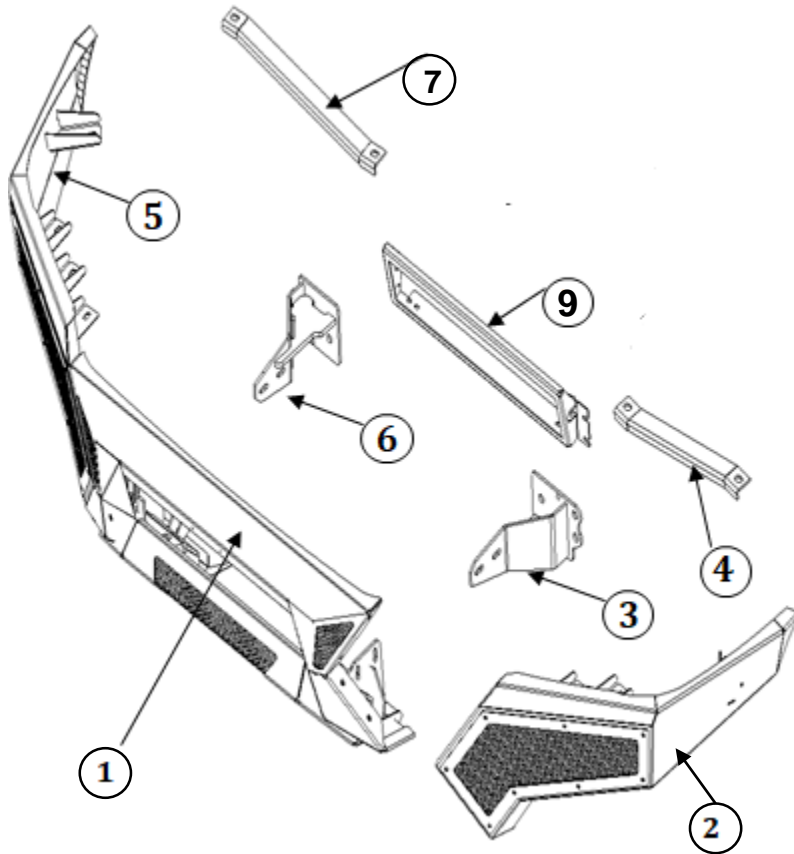

ITEM	QTY	PART
1	1	CENTER FRONT BUMPER REPLACEMENT
2	1	DRIVER WING WITH MESH & FRAME
3	1	DRIVER MAIN BRACKET
4	1	DRIVER AUXILIAR BRACKET
5	1	PASSENGER WING WITH MESH & FRAME
6	1	PASSENGER MAIN BRACKET
7	1	PASSENGER AUXILIAR BRACKET
9	1	STATIC LIGHT BAR BASE (Factory installed)

ITEM	QTY	Hardware
1	10	3/8" x 1" Hex Bolt
2	4	3/8" x 1 1/4" Hex Bolt
3	6	3/8" Hex Nut
4	16	3/8" Flat Washer
5	14	3/8" Lock Washer
6	4	3/8"x 1 1/4" Carriage Bolt
7	2	3/8 Bolt Wire Guide
8	4	3/8" Vinyl Washer
9	2	3/8" Paired Bolt Plate
10	2	1/4" x 3/4" Button Head Screw
11	4	1/4" Flat Washer
12	2	1/4" Lock Washer
13	2	1/4" Hex Nut

ITEM	QTY	Lightbar Hardware Kit
1	2	3/4" OD Spacer
2	2	M8x 1.25MM x 35MM Hex Bolt
3	2	M8 Lock Washer
4	2	M8 Flat Washer

Go Rhino recommends you, the installer, read this installation instruction manual from front to back before installing the product. You may also [click here](http://www.gorhino.com/Installation-Videos) to view an installation video or visit <http://www.gorhino.com/Installation-Videos>.

This product requires cutting of the original bumper and fender liner. It is recommended to seek professional installation for installation. The installer assumes all responsibility for installation and issues that may occur during installation.

TOOLS NEEDED FOR INSTALLATION:

- 3/8" Socket & Wrench
- 1/4" Socket & Wrench
- Allen tip 5/32"
- Ratchet & Extension
- 3/8" mix wrench

ESTIMATED TIME FOR INSTALLATION:

3-4 Hours

If you need installation service for your new product, call the authorized distributor from whom you purchased the product or an authorized installation service company which can be found by calling toll free 1-888-427-4466

GO RHINO®

INSTALLATION INSTRUCTIONS

Before you begin installation, be sure to inspect all the contents of your bumper and verify you have all the correct parts. The cutting of the OEM bumper can be performed with the OEM bumper removed or with the bumper installed. Pages #-# will cover how to remove the OEM bumper. If you desire to remove the bumper to cut it, please refer to the removal steps to reinstall it once you have made the necessary cutting. You will need to reinstall the cut OEM bumper and grill before you proceed to install the Element bumper.

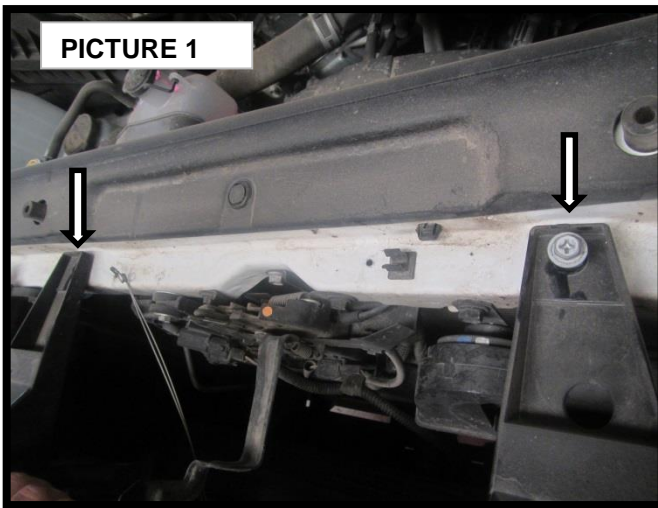

Begin the installation on the top of the vehicle, remove two grill screws (PICTURE 1). Remove two clip securing in back to the front grille. (PICTURE 2).

Pull up & out the grill holders carefully to the front, and then insert one hand between grill & frame, then remove grill holders (10 clips), then pull out the grill.(PICTURE 3)

GO RHINO®

INSTALLATION INSTRUCTIONS

In front half of lower cover, remove the screws from driver & passenger sides as show in pictures 4, 5, 6 & 7. Remove the down lower cover screw & all bottom deflector screws. (PICTURE 8)

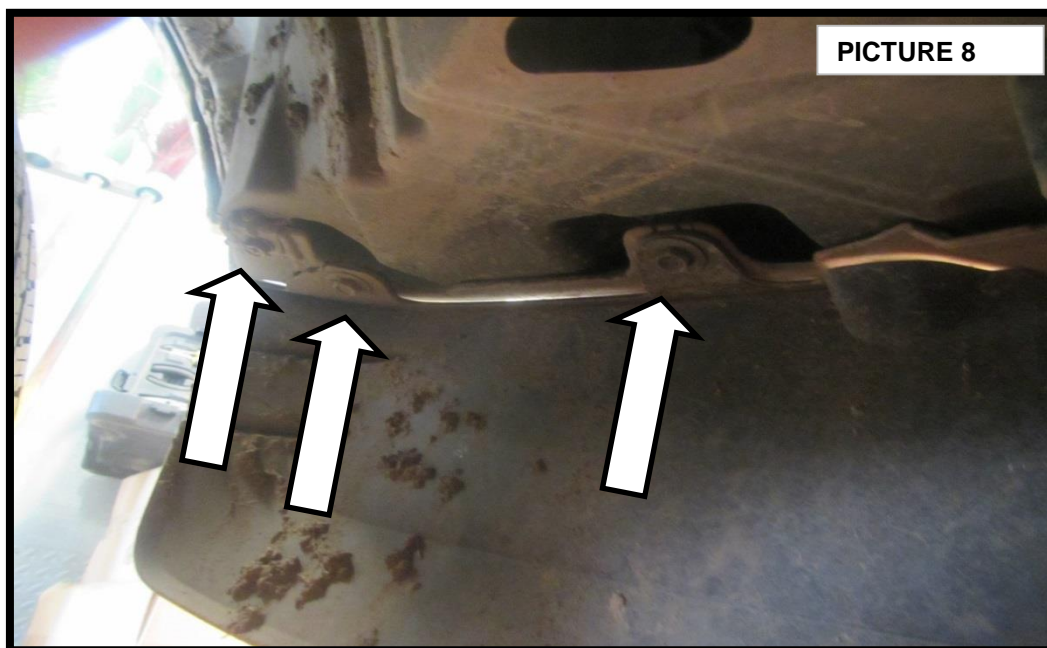

GO RHINO®

INSTALLATION INSTRUCTIONS

Remove the lower covers from the passenger and driver sides. (PICTURE 10) If equipped with front park assist and/or fog lamps, disconnect the sensor and/or lamps wiring pig tail from the vehicle wiring harness. (PICTURE 10)

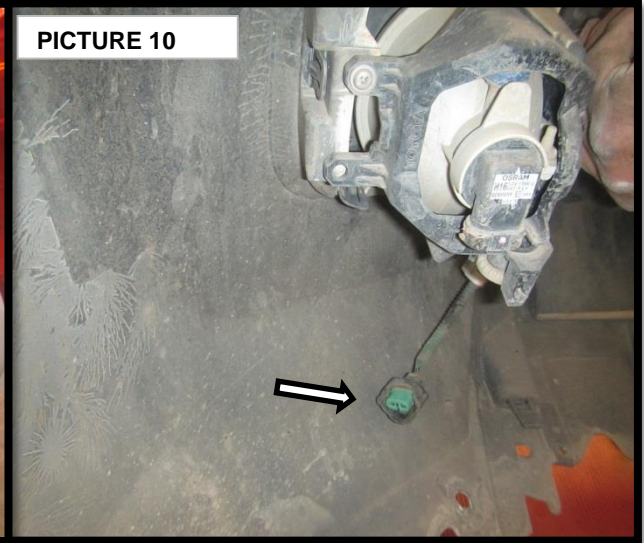
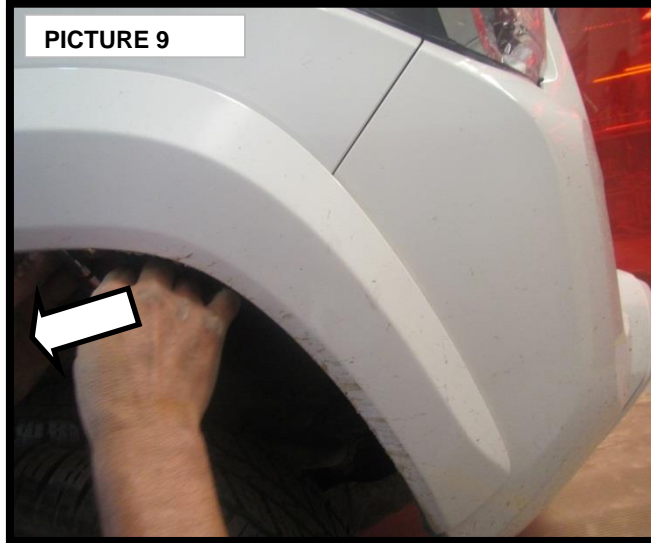

Release enough of the plastic clips holding your fender flare on to be able to pull it back and out of your way. You may remove this flare completely if you desire, but it is not necessary. (PICTURES 11 & 12)

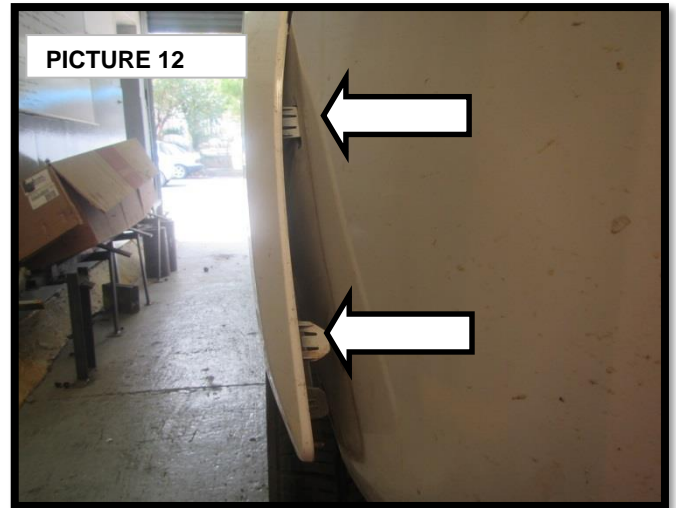
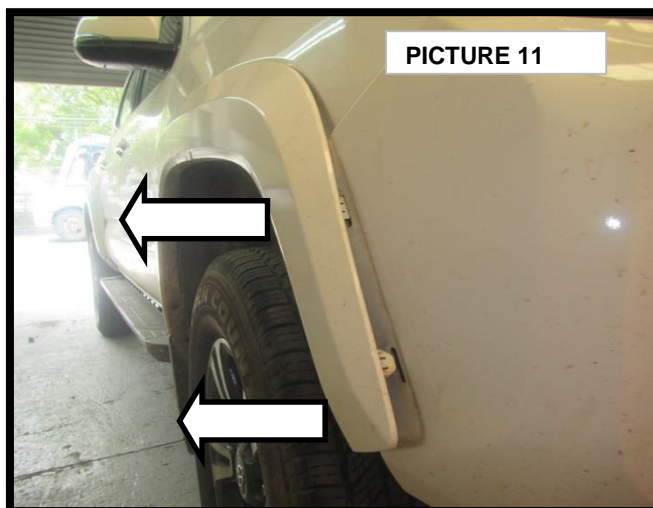

GO RHINO®

INSTALLATION INSTRUCTIONS

Remove four front bumper lower screw. (PICTURES 13 & 14) and remove four securing clip from bumper as indicate. (PICTURES 14 & 15) With assistance remove the bumper from the vehicle as shown.

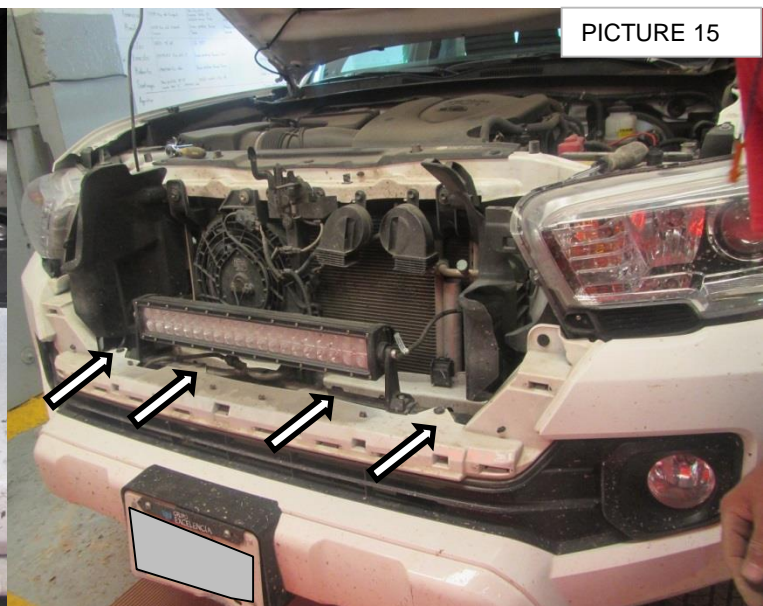
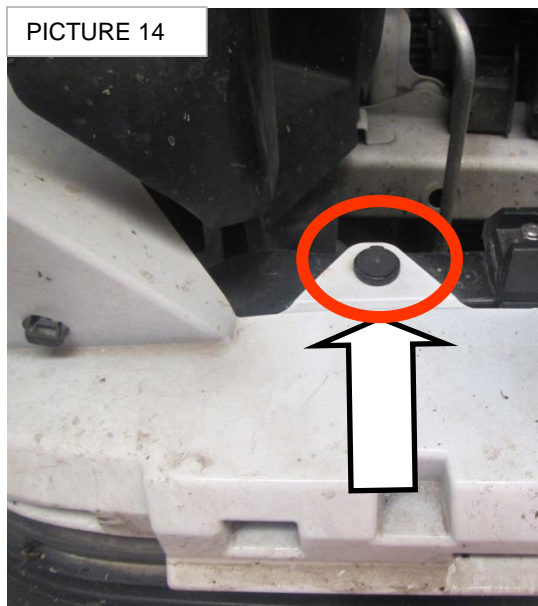
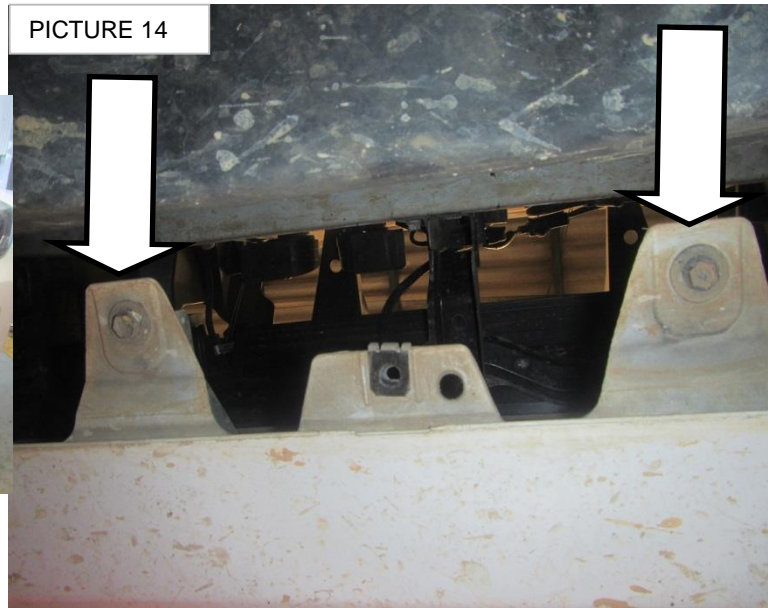

GO RHINO®

INSTALLATION INSTRUCTIONS

Remove the six nuts of aluminium Bumper Reinforcement, and pull out the Bumper Reinforcement (PICTURES 18, 21 & 22)

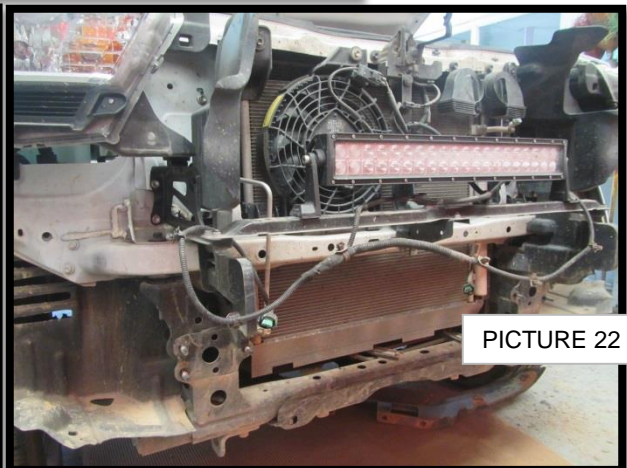
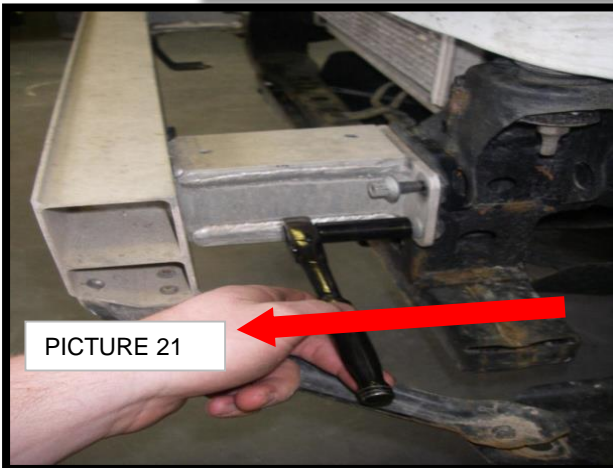
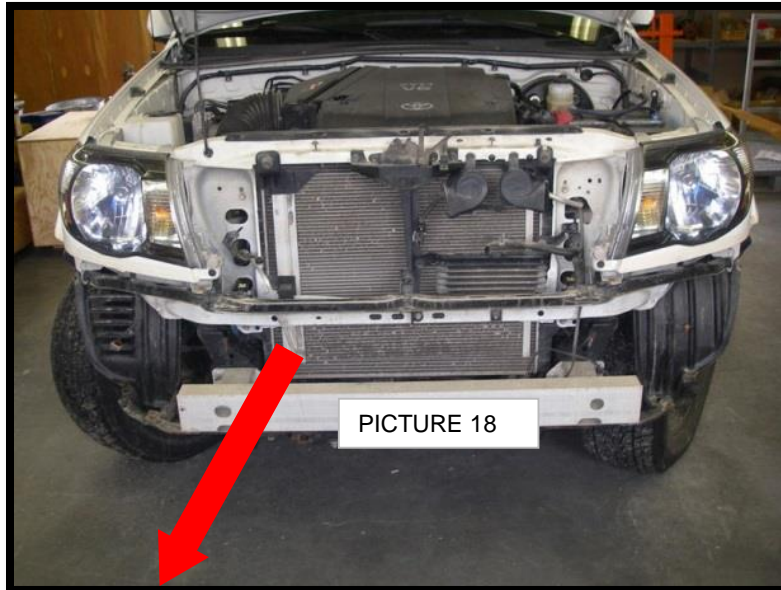



INSTALLATION INSTRUCTIONS

Cutting the OEM bumper

***This task should be performed by an experienced installer and is NOT recommended to be installed without experience ***

This product requires cutting of the original bumper and fender liner. It is recommended to seek professional installation for installation. The installer assumes all responsibility for installation and issues that may occur during installation.

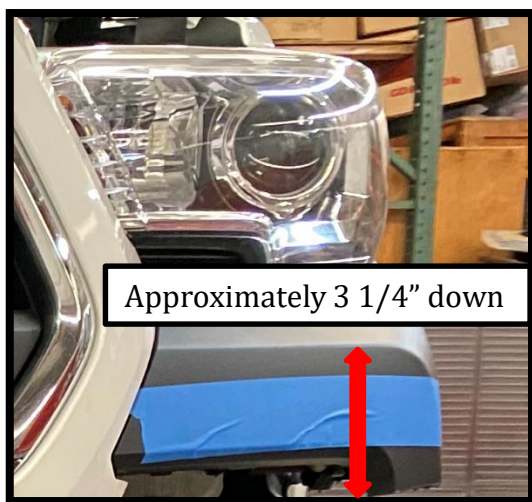
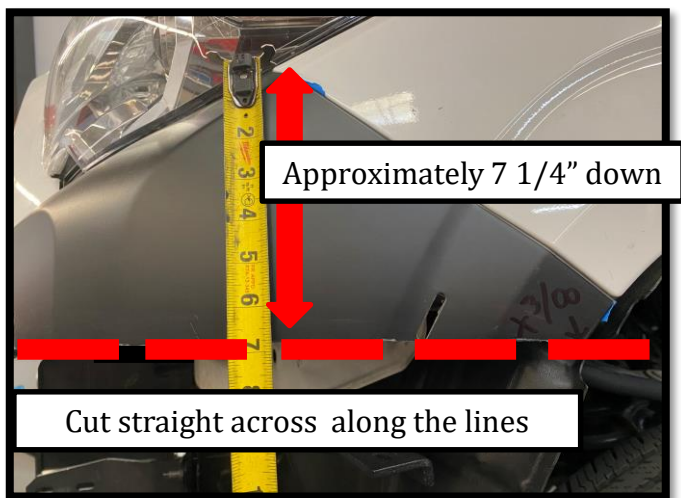

Remove OEM fog light housing from the back of the bumper (refer to your OEM repair manual). This will prevent you from damaging it while cutting the bumper. From where the headlight, fender and bumper meet, measure down 7 1/4" inches. You can use painters tape to help make a straight cut from the end of the bumper to the fog light pocket. To cut, you can use a cutting wheel or dremel saw or box cutter. There will be excess bumper material but most of it will tuck inside the Element bumper. This is done to allow the installer fine tune to their desired fitment. Note that cutting can be done with the OEM bumper cover installed or off the vehicle. Shown in the image is the bumper installed as it helped the bumper keep its shape while being cut. ******* If your Tacoma has the OEM outer fender flares, do not cut those. Those will be cut at a later step on the install*******

If you removed the OEM bumper to perform the cut, you can reinstall the OEM bumper and grill now. Use painters tape to protect the finish

GO RHINO®

INSTALLATION INSTRUCTIONS

Once you have cut your bumper, you will need to reinstall the upper cut portion and grill. Use painters tape to prevent any damage to the paint when installing the Element bumper. Follow removal steps in a backwards manner on reinstallation process (pages 4-7).

Install the paired bolt plate into the frame horn. You'll need to remove the rectangular plastic plug on the inside of the frame to have an access point. Be sure to use the supplied guide wire to feed it inside the frame and exposed as a stud. Use the supplied vinyl washers on the bolt plate studs to prevent them from falling side the frame horn. Repeat process for both sides.

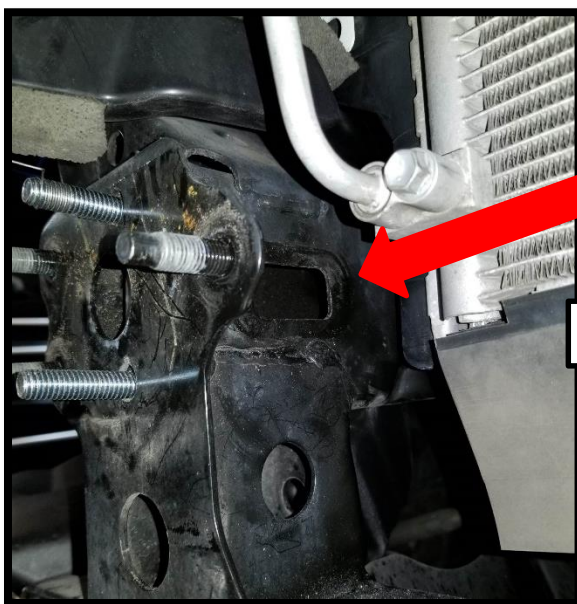
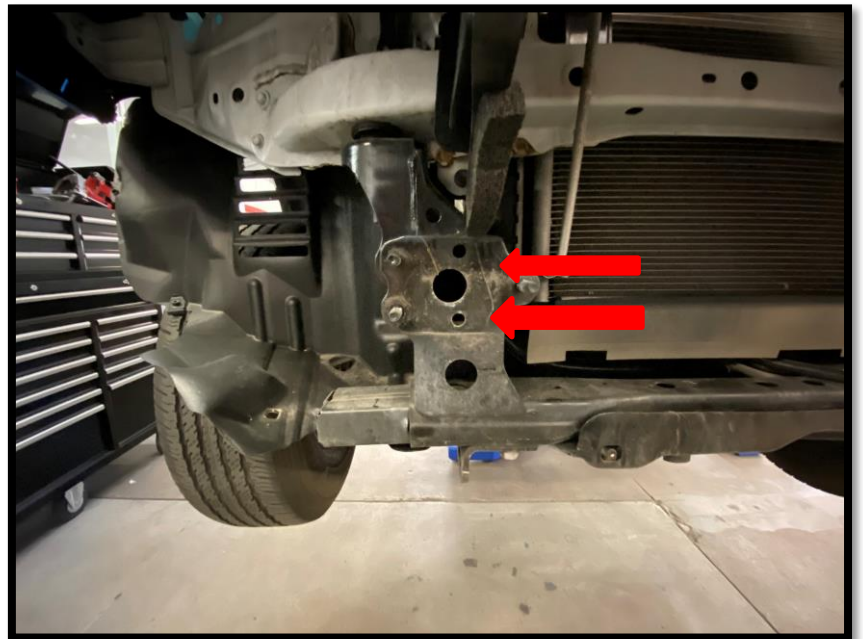

Paired bolt with wire guide

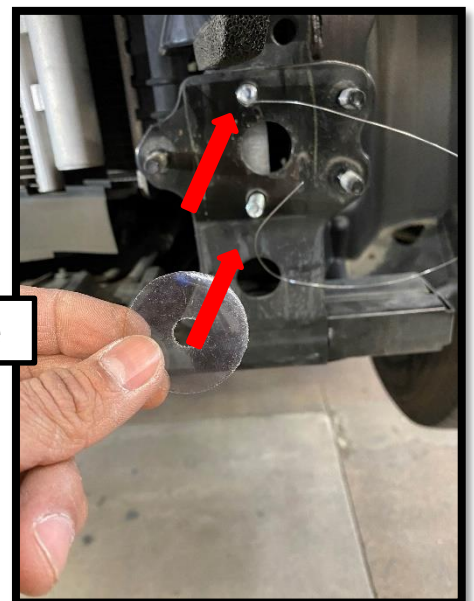

GO RHINO®

INSTALLATION INSTRUCTIONS

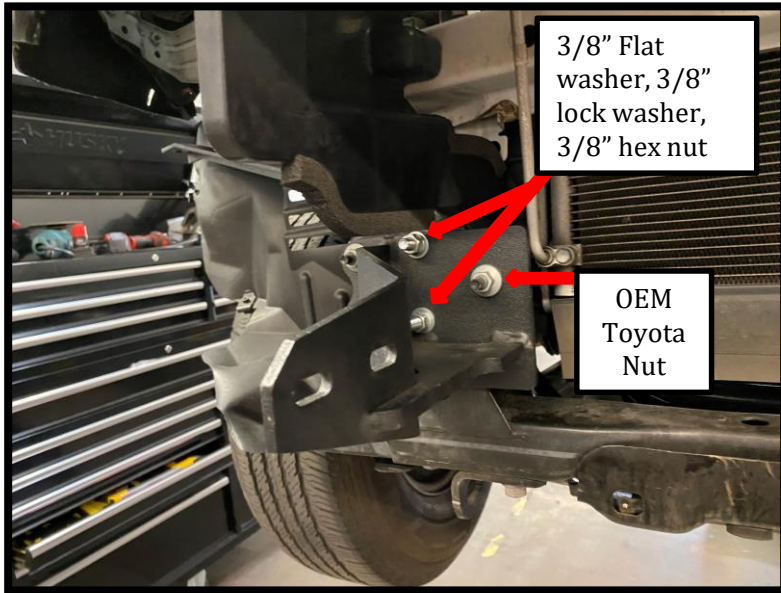

Install frame brackets. Reuse the OEM frame nuts on the larger threads (from page #. Use two 3/8" flat washers, two 3/8" lock washers and two 3/8 hex nuts to fasten the exposed studs on the bolt plate. Leave finger tight for final adjustment. Repeat process for both sides.

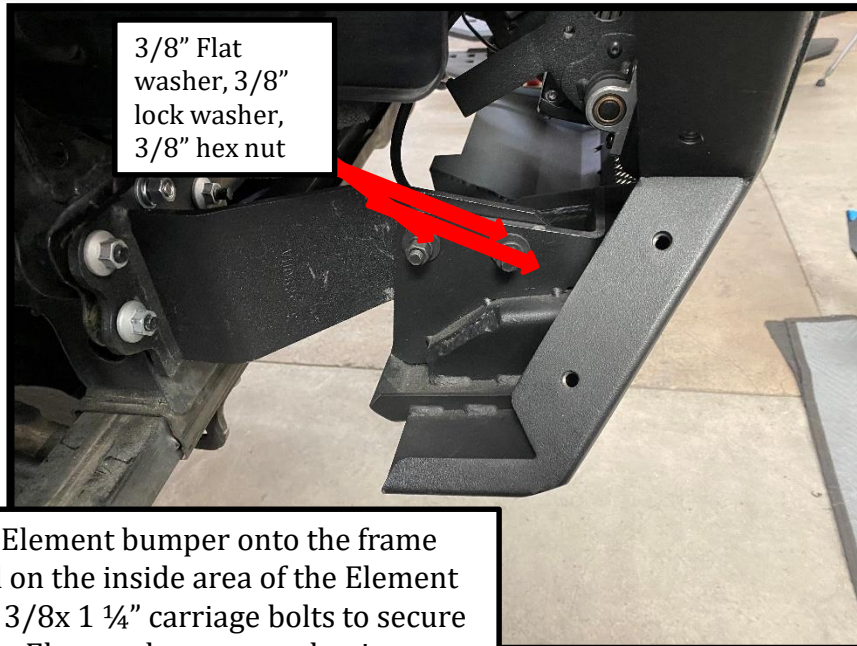
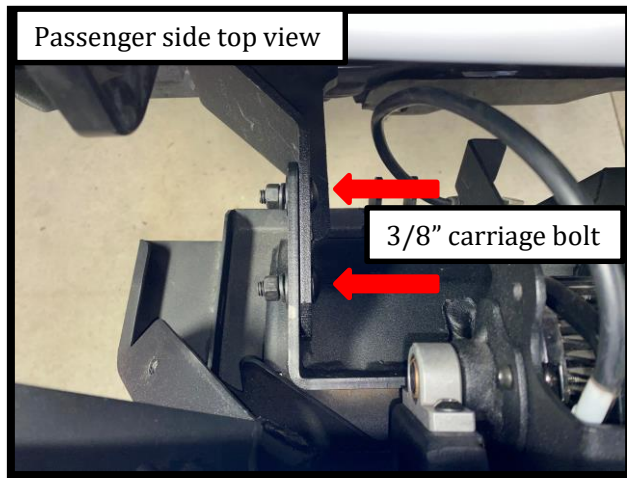

With assistance, position the center section of the Element bumper onto the frame brackets. Note that the frame horn brackets install on the inside area of the Element center section. You will need to use two (per side) 3/8x 1 1/4" carriage bolts to secure it. Introduce the carriage bolt from the inside of the Element bumper so that it protrudes as a stud. Fasten one 3/8" flat washer, one 3/8" lock washer, one 3/8" hex nut per carriage bolt. Leave finger tight for final adjustment. Repeat process for both sides.

GO RHINO®

INSTALLATION INSTRUCTIONS



Remove OEM front body mount nut to install outer auxiliary brackets. Install auxiliary bracket in place with OEM washer in the same position. The auxiliary bracket should sandwich itself between the OEM mount washer and OEM mount nut. Refer to your OEM manual on removal process.

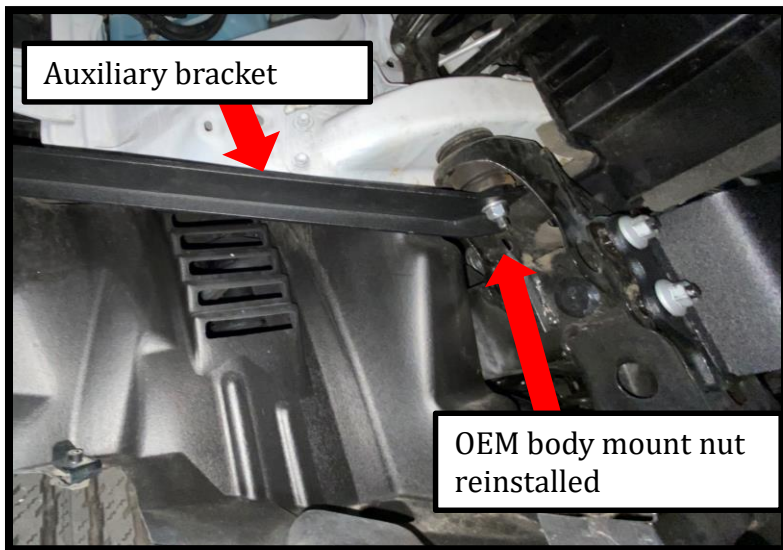

Install auxiliary bracket with the fold facing the tires (see image) and fasten the OEM body mount nut back in place. Leave finger tight to allow for final adjustment. For torque settings, please refer to your OEM repair manual.

GO RHINO®

INSTALLATION INSTRUCTIONS

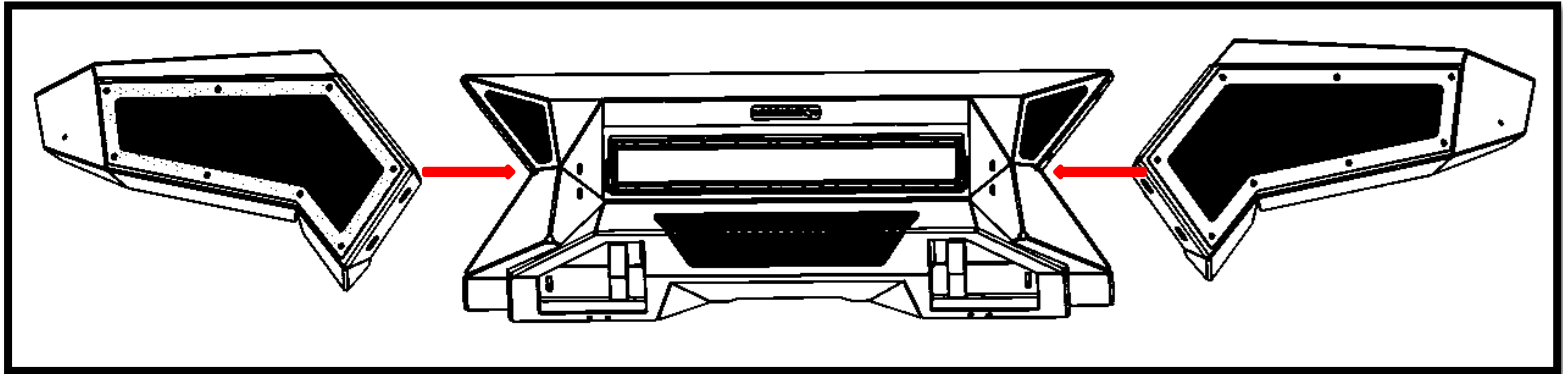

Install outer wings (without the mesh covers) onto the center section of the bumper. Exercise caution when installing each side to that you don't damage your paint. Each side with use four 3/8" hex bolts, four 3/8" lock washers, four 3/8" flat washers. This can be done with the mesh covers off as it will allow for greater access to the welded nuts on the center section.

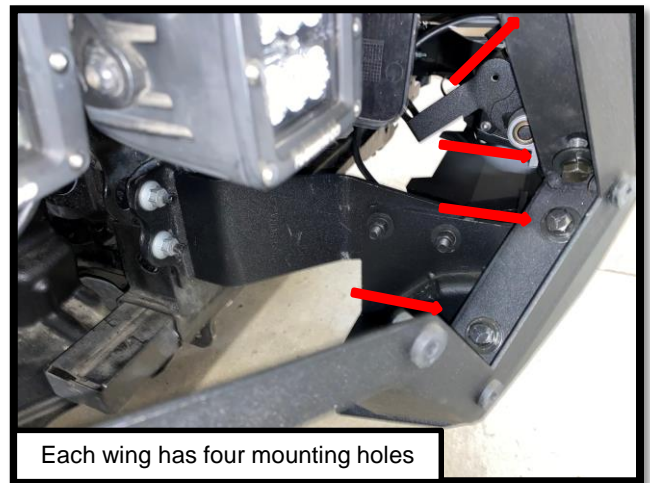

Each wing has four mounting holes

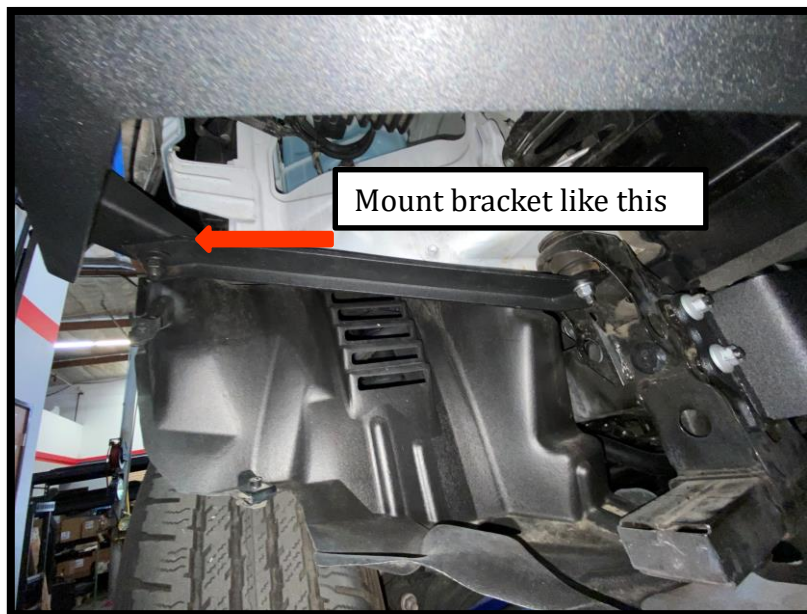

Once both wings are installed, connect outer auxiliary bracket to the outer part of the wing. The auxiliary bracket sits on the bottom of the welded bracket on the bumper wings. Use one 3/8" x 1 hex bolt, two 3/8" flat washer, one 3/8" lock washer and one 3/8 hex nut. Leave finger tight and repeat process for both sides.



INSTALLATION INSTRUCTIONS

Element Bumper Fitment

Due to the multi-piece construction, the Element bumper provides different adjustment points to fit your truck. This is why we state to leave additional material on your OEM bumper, which can be cut to fine tune it to your liking.

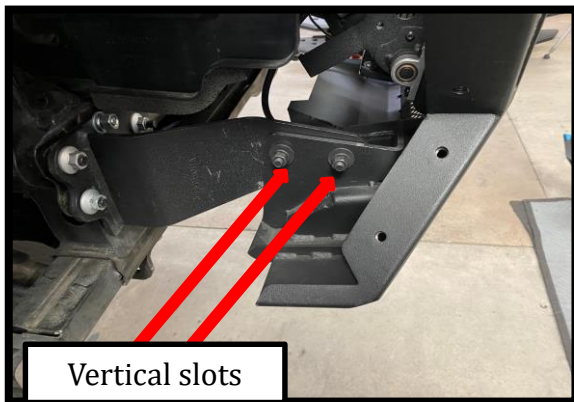
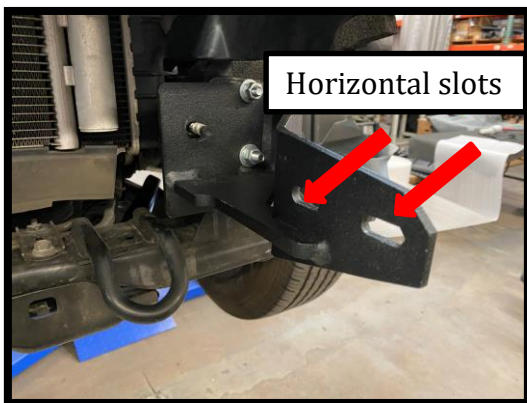

Adjust your bumper to square up with the front end and fasten any loose hardware accordingly. The bumper should not make any contact with the OEM bumper or grill. It should have an approximate $\frac{1}{4}$ " - $\frac{1}{2}$ " spaced away from the OEM bumper. The wings of the bumper should meet where the fender and OEM bumper meet. The excess plastic the as left when the bumper was cut should tuck inside of the Element bumpers. If you should find that the OEM bumper is making contact, evaluate where it and trim the OEM as needed.

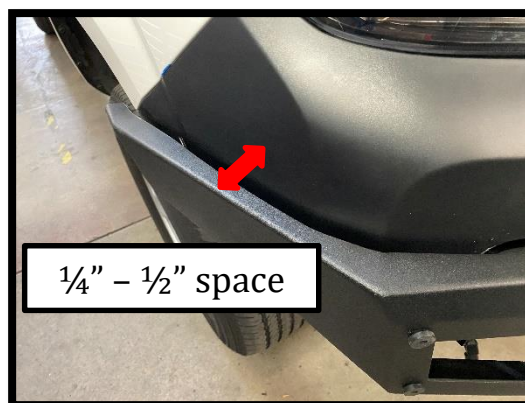

GO RHINO®

INSTALLATION INSTRUCTIONS

*****This task should be performed by an experienced installer and is NOT recommended to be installed without experience ******

•This product requires cutting of the original bumper and fender liner. It is recommended to seek professional installation for installation. The installer assumes all responsibility for installation and issues that may occur during installation.



Once you have adjusted the fitment on your bumper, you can cut the fender liners. Depending on your desired look, you can cut the OEM fender liner by following the Element bumper lines. With caution, use a cutting wheel or box cutter to cut the inner fender liner. If you prefer to cut more material, please refer to the images below. You can sand the edges to so they are not left sharp.

******* Cut thru the lower covers approximate 3"-4" from the upper end Reattach the rest of the lower cover in they original position .**



GO RHINO®

INSTALLATION INSTRUCTIONS

- This product requires cutting of the original bumper and fender liner. It is recommended to seek professional installation for installation. The installer assumes all responsibility for installation and issues that may occur during installation.



Once you are satisfied with the fitment of your bumper, you can cut the oem fender flares. Make a straight cut across so that the fender flare sits flush to the wings of the Element bumper. Use painters tape a guide.



GO RHINO®

INSTALLATION INSTRUCTIONS

BACKSIDE VIEW

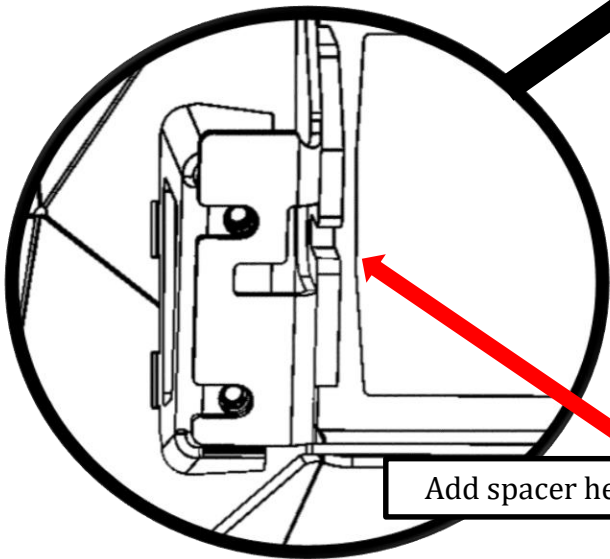
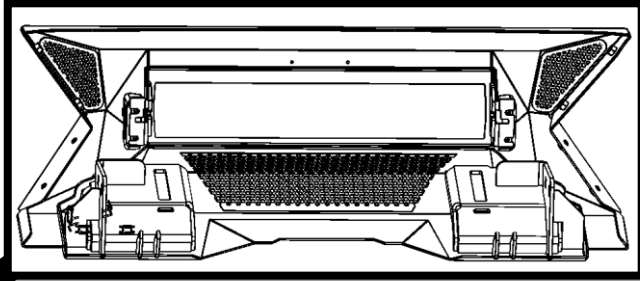

Depending on the light bar brand you decide to use, you may find that it will require spacers to fill in any voids. We supply $\frac{3}{4}$ " OD plastic spacers. They are to be installed on the backside of the bumper, where the light bar mount is located.

Add spacer here if needed

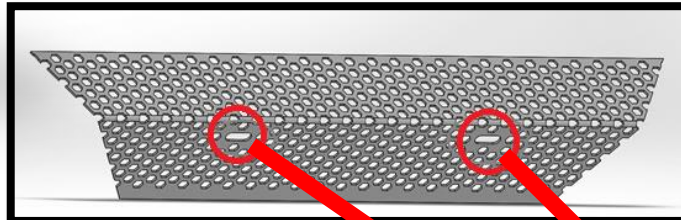

If your state law requires a front license plate, attach the license plate to the holes in the face of the bumper shell, using the supplied $\frac{1}{4}$ " x $\frac{3}{4}$ " button head bolts, $\frac{1}{4}$ " washer, $\frac{1}{4}$ " lock washer and $\frac{1}{4}$ " nuts, and the license plate to the (2) elonged holes in lower mesh area.



GO RHINO®

INSTALLATION INSTRUCTIONS

Periodically check that the hardware is fastened.





INSTALLATION INSTRUCTIONS

LIMITED WARRANTY

Go Rhino warrants to Buyer that for a period of five (5) years from the date of shipment of the product(s) ("Warranty Period") for black finishes and chrome finishes, that such products will materially conform to the specifications set forth in Go Rhino's specifications in effect as of the date of shipment(s) and will be free from material defects in material workmanship.

Go Rhino warrants to Buyer that for the life of the product(s) from the date of shipment of the product(s) ("Warranty Period") for polished stainless steel finished products purchased after April 2004, that such products will materially conform to the specifications set forth in Go Rhino's specifications in effect as of the date of shipments and will be free from material defects in material workmanship.

Warranty claims must be accompanied with the original invoice and photos of the product. It is the customer's responsibility to clean regularly and protect finish with regular applications of a nonabrasive polish that is compatible with the product's finish.

This warranty covers the cost of the product only and does not include the cost of removal, installation, third party modifications or shipping of the product. In no event shall Go Rhino be liable to buyer or any third party for any damage or harm caused by the product or use thereof, regardless of weather such damages were foreseeable and whether or not Go Rhino has been advised of the possibility of such damages, not withstanding the failure of any agreed or other remedy of its essential purpose. This warranty is void if the product shows signs of alteration, misuse, mishandling, improper care, neglect, improper application and/or damage due to improper installation.

With respect to any such product(s) during the limited warranty period, Go Rhino shall, in its sole discretion, either: (i) provide a one-time repair or replacement of such products (or the defective part) or (ii) credit or refund the price of such products at the pro rata contract rate provided that, if Go Rhino so requests, Buyer shall, at Go Rhino's expense, return such product(s) to Go Rhino. The remedies shall be the Buyer's sole and exclusive remedy and Go Rhino's entire liability for any breach of the limited warrant(ies).

Go Rhino disclaims all other warranties except to the extent that any such warranty cannot be validly disclaimed under applicable law.

Finish Limited Warranty:

Limited lifetime on stainless steel products (after April 2004)
5 year warranty on black powder coat products
5 year warranty on chrome products
This warranty does not cover exposed welds

Finish warranty covers peeling, flaking, or cracking. Washing all finishes regularly with car wash soap and rinsing well with water is the best method for maintaining the finish on your products. You must also protect the finish with nonabrasive automotive wax on a regular basis. The use of any compound which contains abrasives becomes a self-defeating exercise as the compound scratches the finish and opens it to corrosion. The use of harsh chemicals used to remove bugs and tar may also cause the finish to fail and should be avoided.

If you are unsatisfied with your purchase please contact the establishment you purchased the product from.

If you need to place a warranty claim or need assistance, the Go Rhino customer service team will answer any questions you may have. Please contact the Go Rhino customer service team at 1-888-427-4466 during normal business hours Monday thru Friday 7 am to 5 pm PST. You may also email warranty@gorhino.com. In order to better serve you please provide a copy of the original invoice / receipt, a photo of the issue you are experiencing and a photo of the vehicle the product is installed on.

All warranty returns must have an approved RGA number. The RGA number must be clearly marked on the exterior of the return package. All approved warranty returns must be shipped to Go Rhino Products, 1002 Carriers Drive, Laredo, Texas 78045.

PRODUCT REGISTRATION

Please remember to register your new purchase. You may register your product at www.gorhino.com. Registering your product may help speed any future warranty or customer service inquiries.

Thank you again for purchasing from Go Rhino Products

Please take a few minutes to view additional products for your vehicle and more at GORRHINO.com
These installation instructions are available on the Go Rhino web site along with installation videos for many of our products.

www.gorhino.com

www.bigcountryauto.com

www.gorhinopd.com